

VISIT SITE NOW >>

RADFORD 6150

Self Priming Sewage Pumps

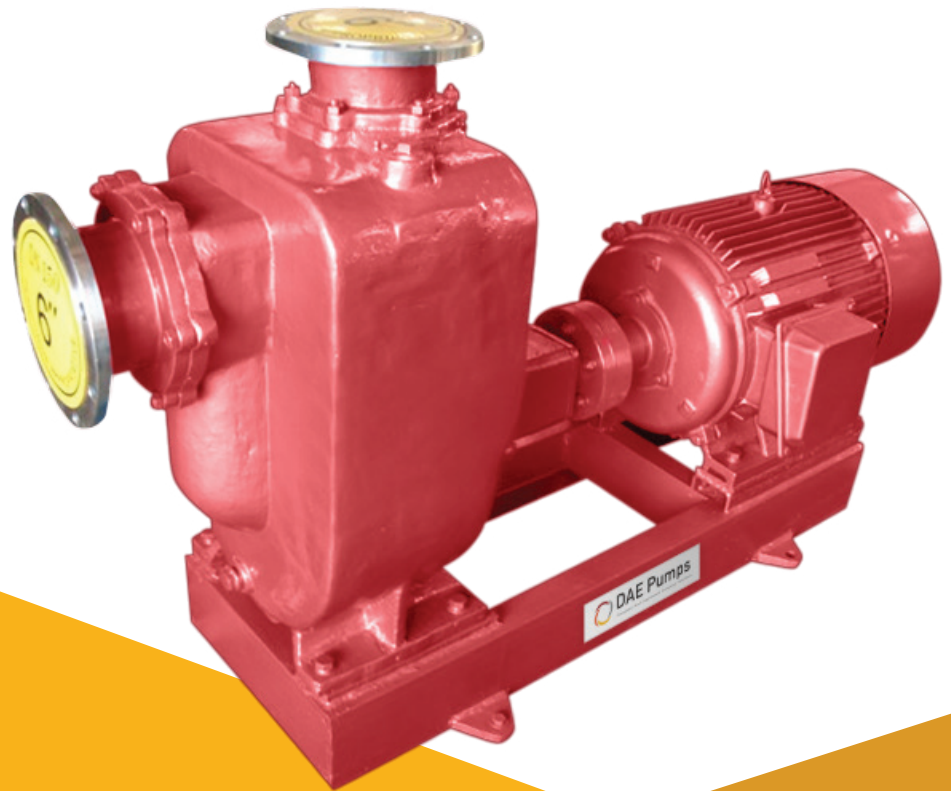

DAEPUMPS.COM

info@daepumps.com

(760) 821-8112

VISIT SITE NOW >>

RADFORD 6150 SELF PRIMING SEWAGE PUMPS

The DAE Pumps Radford 6150 series self-priming sewage pump is a new structured product developed based on the reaping study of domestic and similar foreign technology. The product is mainly used for pumping sewage from cities, factories, and mines. It is characterized by its high efficiency, low noise, and long service life. Therefore, the product is an ideal choice for sewage treatment.

This durable self-priming sewage pump with 6-inch discharge can move liquid at 790 GPM via 20 horsepower. The Radford 6150 is made of gray iron pump casing, chromium iron impeller, and a stainless steel motor frame, shaft and strainer.

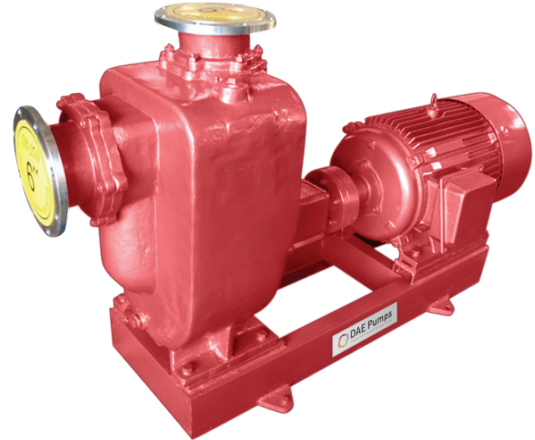

APPLICATION

This kind of pump combines self priming and non-clogging, adopting axial circumfluence outer-mi type. And through the particular design of case and impeller channel, it not only needn't be fixed with a base valve and poured in water like normal self priming, but also can suck and discharge liquid containing big grain and long fibrin substance. So it is widely used in municipal sewage projects, river and pond breeding, light industry, papermaking, weaving, foodstuff, chemical industry, power industry, fibrin, slurry and mixed suspension etc chemical medium.

P (kW) H (m) E (%)

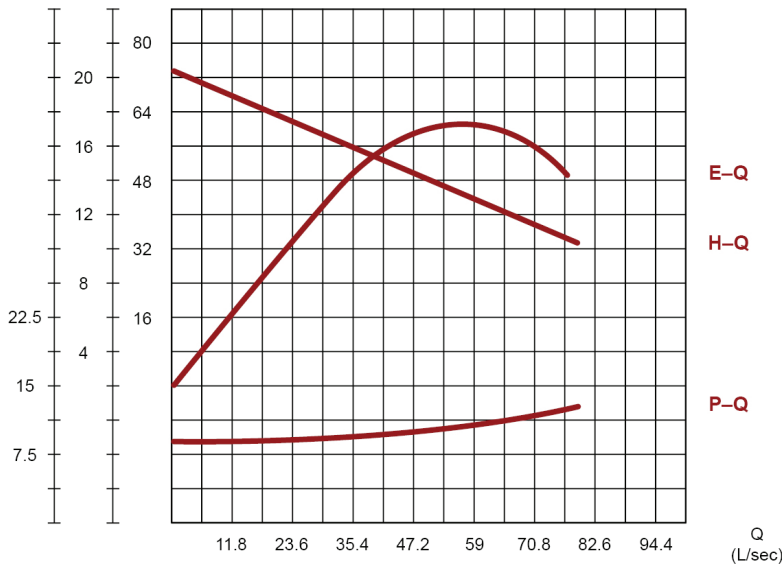

FEATURES:

- Water density up to 9.18 lb/gal
- Top discharge
- Solid handling .27-inches
- pH values from 5 to 8
- Ensures protection against water leakage from the cable entry
- Unique aluminum alloy offers the perfect combination of strength, lightweight, and corrosion resistance
- Class F motors, with thermal switches in each winding
- Pump design ensures all-round motor cooling for better performance
- High-chrome (55HRC) impellers provide higher wear resistance

Model	Capacity (GPM)	Head (ft)	Power (HP)	Rotary Speed (rpm)	Efficiency (%)	NPSH@ (ft)	Self-priming height (ft)	Inlet Size (in)
Radford 6150	790	45	20	1450	60	17	15	6

VISIT SITE NOW >>

VISIT SITE NOW >>

STRUCTURE AND WORK PRINCIPLE

Structure: Radford 240 Self Priming Sewage Pumps series self priming non-clogging sewage pump consists of pump body, impeller, back cover, mechanical seal, pump shaft, bearing seat, inlet valve, air-liquid separate pipe, water valve, inlet and outlet connection pipe etc.

Working Principle: Deposit liquid chamber is designed in the pump body. The backflow hole upside and circulation hole down connect the working chamber of the pump. They become axial circumference outer-mix systems. Some liquid has deposited inside of the pump when the pump stops. When pump starts, the deposit liquid with air throws up out under the effect of impeller. Liquid goes back to the working chamber by the gridding of air liquid separate pipe and air is discharged out of the pump. Meanwhile the pump body inside becomes vacuum and it realizes self priming performance.

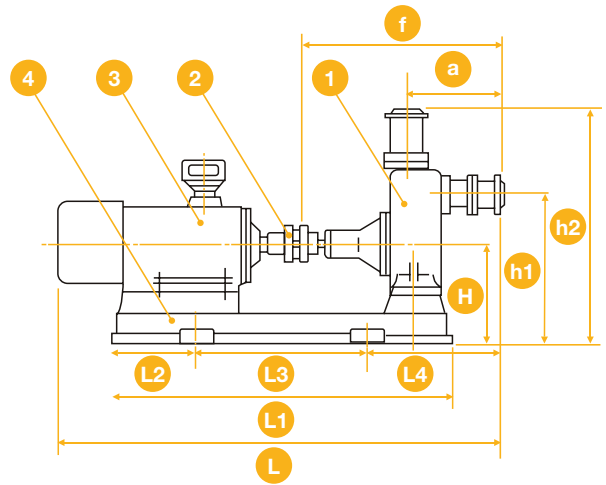

OPERATING CONDITIONS

- Surrounding temperature 50, Medium temperature 80
- Medium consistency should not exceed 1240kg/m³
- Self priming height should not exceed the stated number of 4.5-5.5meters, and the suction pipe should not be over 10 meters long
- It can pass the suspended grain whose diameter is 60 percent of pump caliber, and the fibrin which is 5 times long of pump caliber
- PH range of liquid: 6-9 (For cast iron pump), 2-13 (For stainless steel pump)

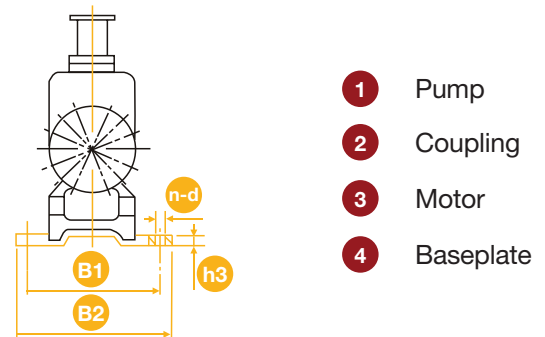

PUMP STRUCTURE

1	Inlet Connector	9	Impeller
2	Inlet Flange	10	Mechanical Seal
3	Inlet valve seat	11	Water Baffle
4	Water valve	12	Bearing Seat
5	Outlet Connector	13	Pump Shaft
6	Pump body	14	Bearing Cover
7	Air-liquid separate pipe	15	Bottom cover Board
8	Back cover	16	Bolt

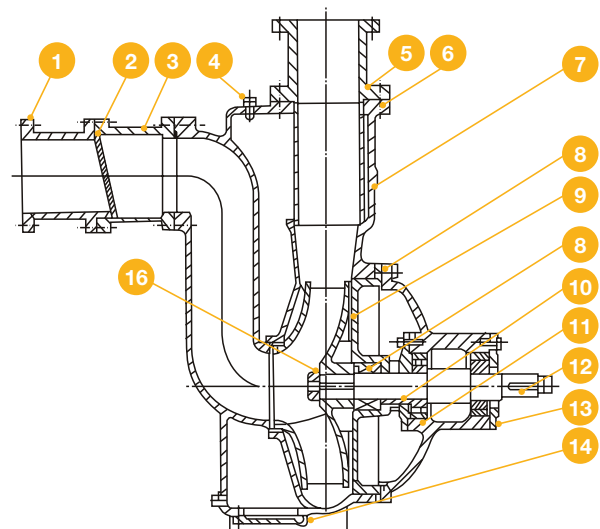

VISIT SITE NOW >>